

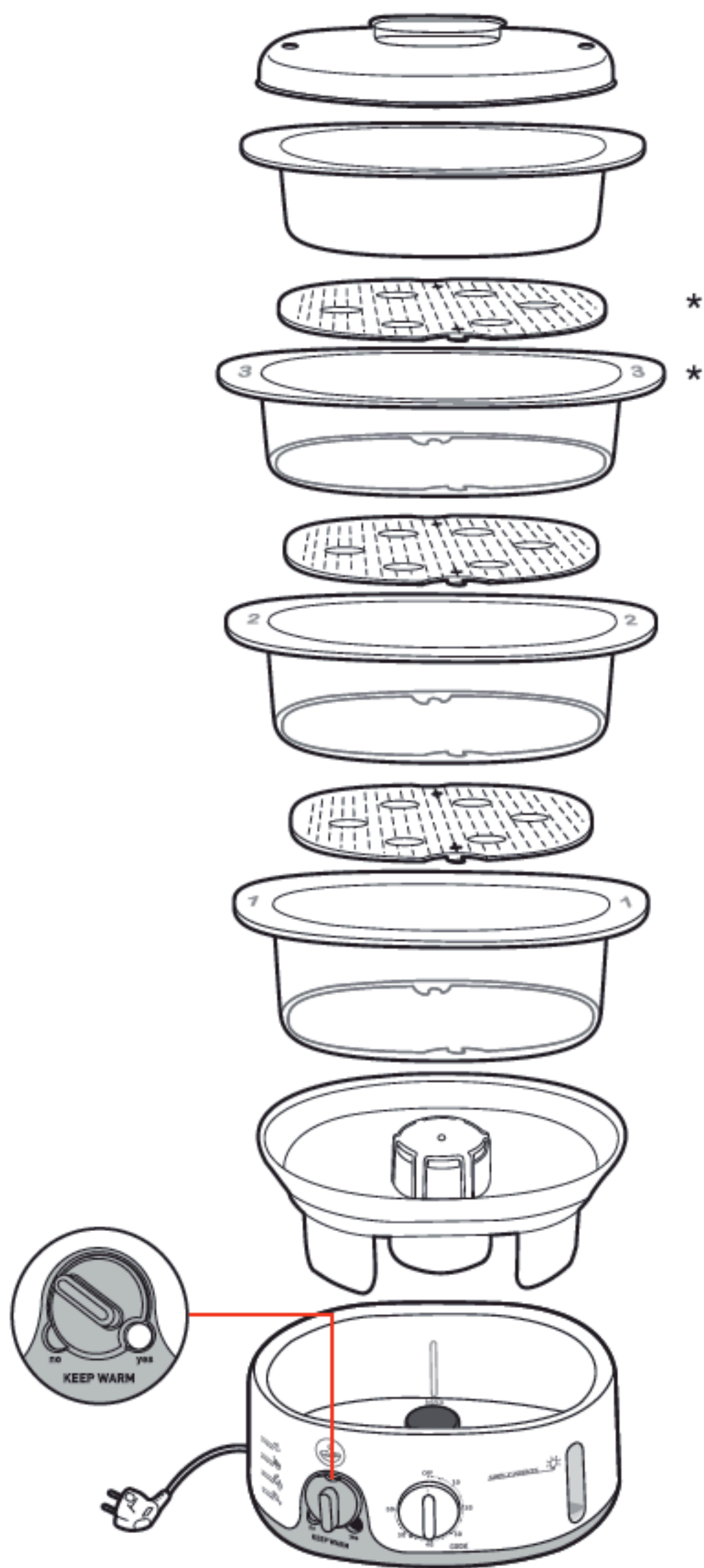

SIMPLY INVENTS

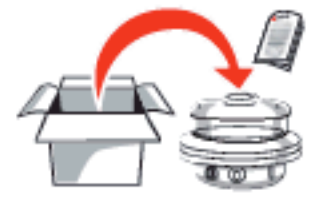



* Selon modèle - Je nach modell - Afhankelijk van het model



1

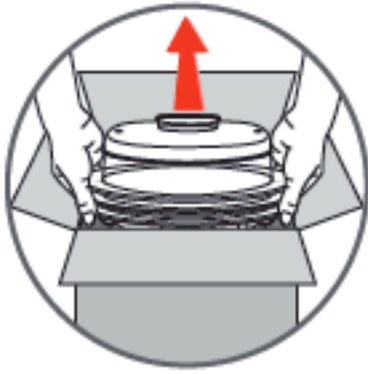

2

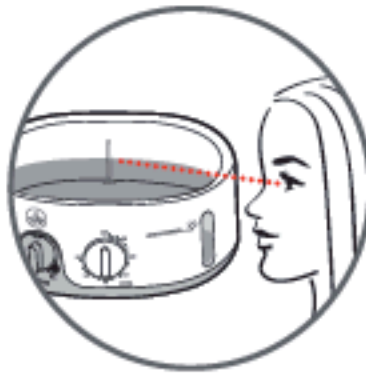

3

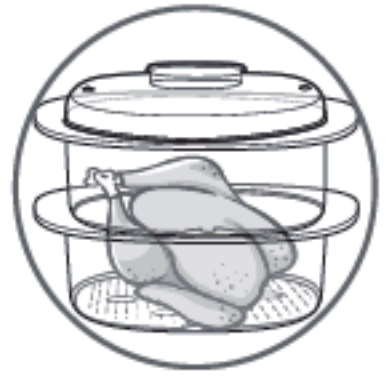
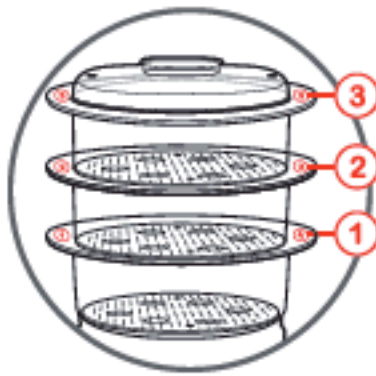

4

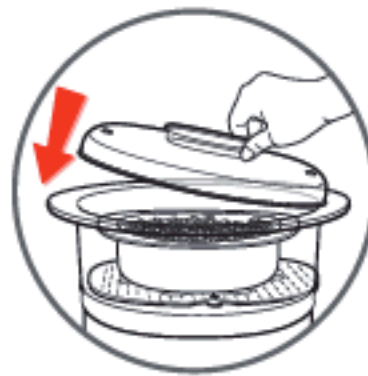

* Eau - Wasser - Water



5

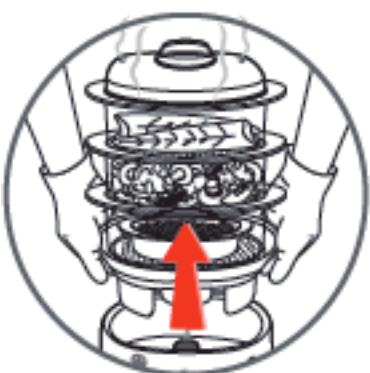

6

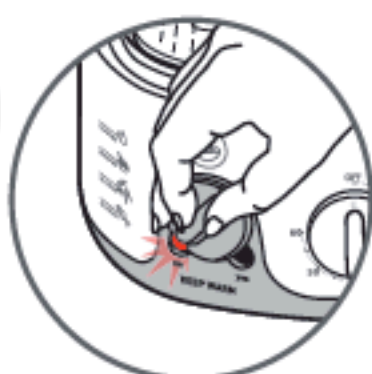

* Eau - Wasser - Water

** Maintien au chaud - Warmhalte-Funktion - Warmhouden

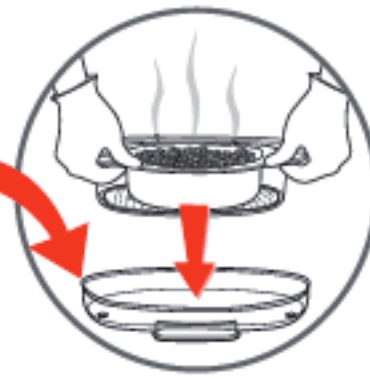

7

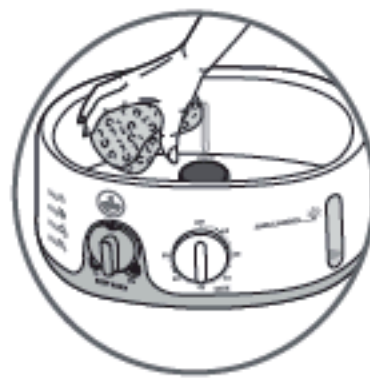
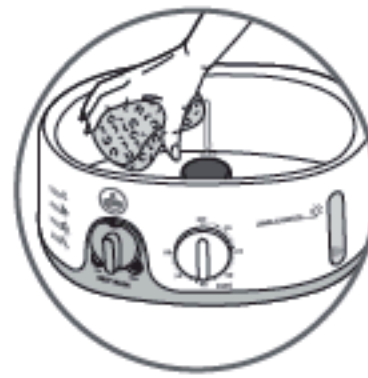
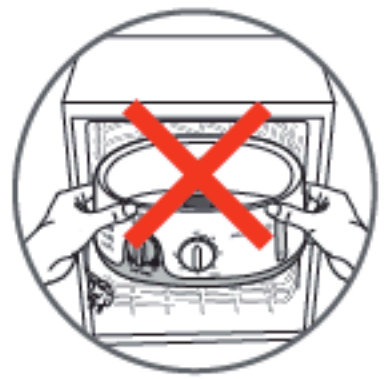



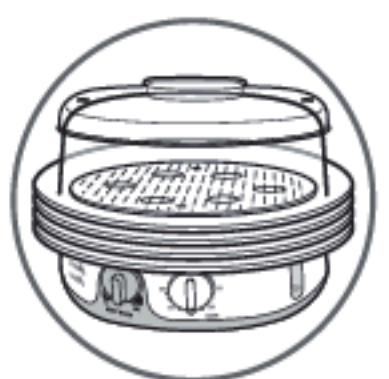
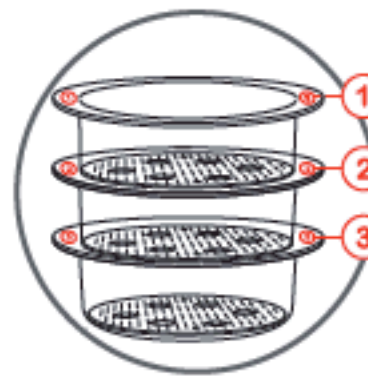





8





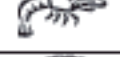



















* Eau - Wasser - Water
** Vinaigre - Essig - Azijn







	 /Nb	
	450 g	8 - 10 min.
	450 g	10 - 15 min.
	400 g	16 - 21 min.
	600 g	25 - 30 min.
	1 kg	15 - 20 min.
	200 g	3 - 7 min.
	100 g	5 - 10 min.

	450 g	15 - 20 min.
	4	30 - 35 min.
	600 g	20 - 25 min.
	450 g	12 - 15 min.
	500 g	10 - 15 min.
	10	8 - 10 min.
	6	15 min.

	3	30 - 35 min.
	400 g	20 - 25 min.
	400 g	16 - 21 min.
	500 g	10 - 15 min.
	600 g	16 - 19 min.
	500 g	10 - 15 min.
	300 g	10 - 12 min.
	500 g	20 - 22 min.

	 /Nb	
	500 g	15 - 20 min.
	500 g	10 - 15 min.
	500 g	15 - 20 min.
	500 g	10 - 15 min.
	400 g	20 min.
	400 g	25 min.
	600 g	40 - 45 min.
	600 g	15 - 20 min.
	400 g	20 - 25 min.
	600 g	12 - 15 min.
	500 g	37 - 48 min.
	300 g	10 - 15 min.
	400 g	10 - 15 min.

			
	200 g	350ml	10 min.
	200 g	400ml	20 - 25 min.
	150 g	300ml	25 - 30 min.
	150 g	600ml	15 min.

	4	10 - 15 min.
	4	20 - 25 min.
	450 g	15 - 20 min.
	4	10 - 15 min.

